

FIGURE 1

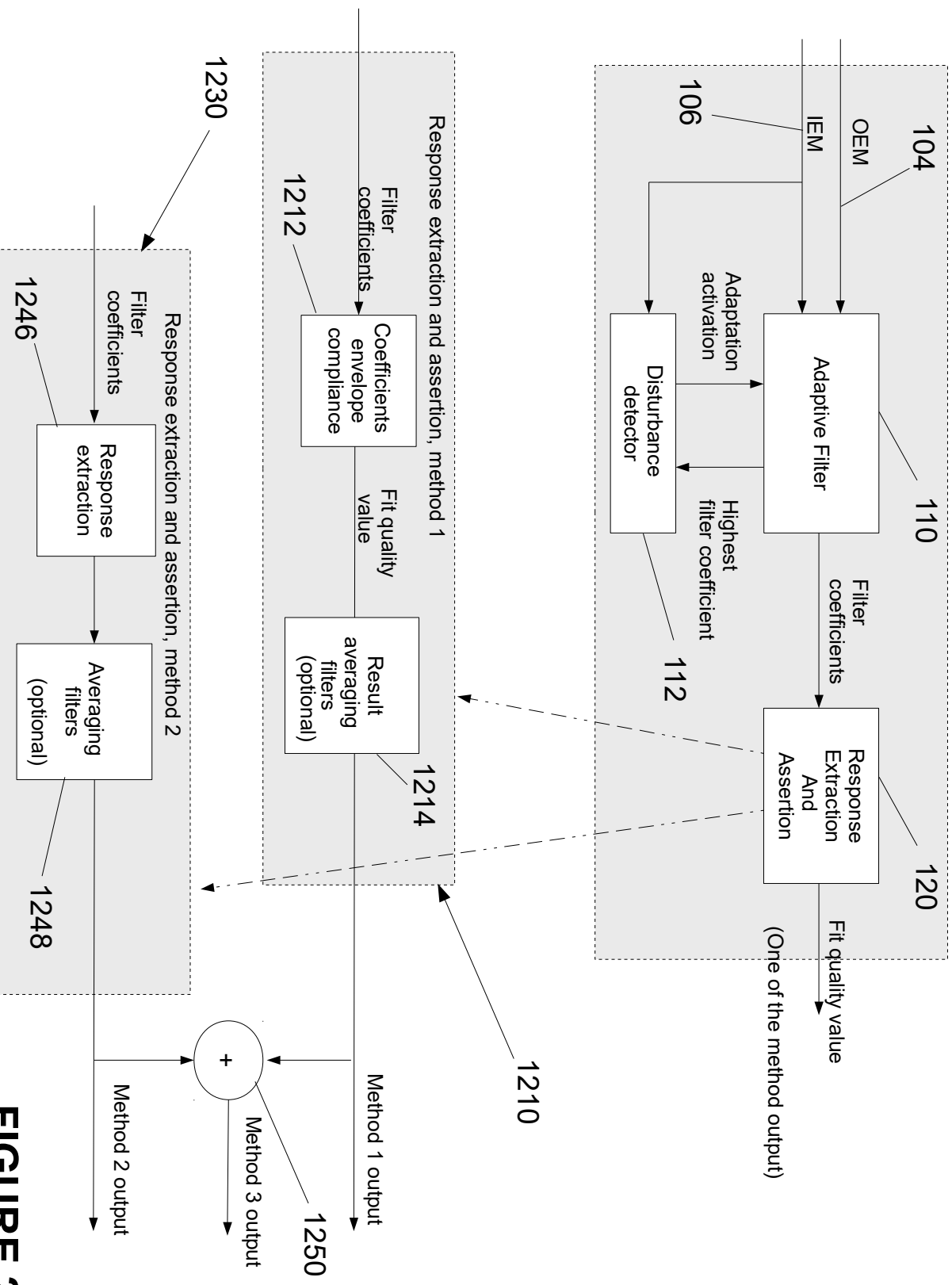
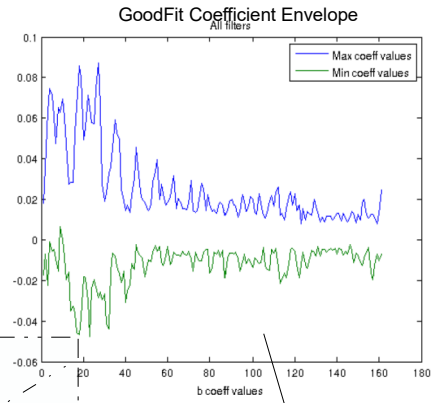
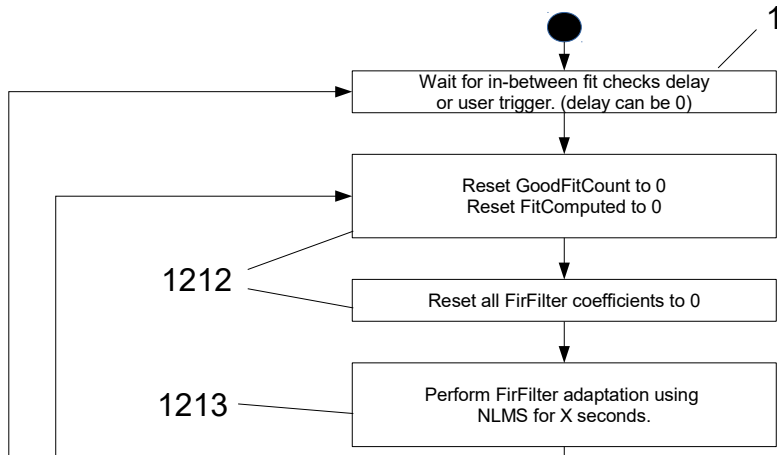

FIGURE 2

120

1211

1210



1214

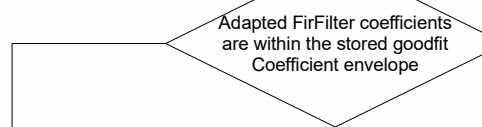

1216



1217

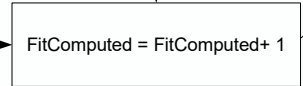

1218



Make sure the case where FitToCompute = 1 is covered. This is to give a Commercial value to the algorithm even if there is no Averaging.

1215

1220



1219

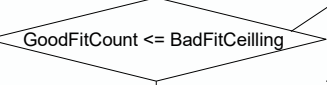

1221

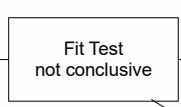

1222

1223



In one embodiment:
FitToCompute = 10
BadFitCeiling = 2
GoodFitFloor = 8

FIGURE 3

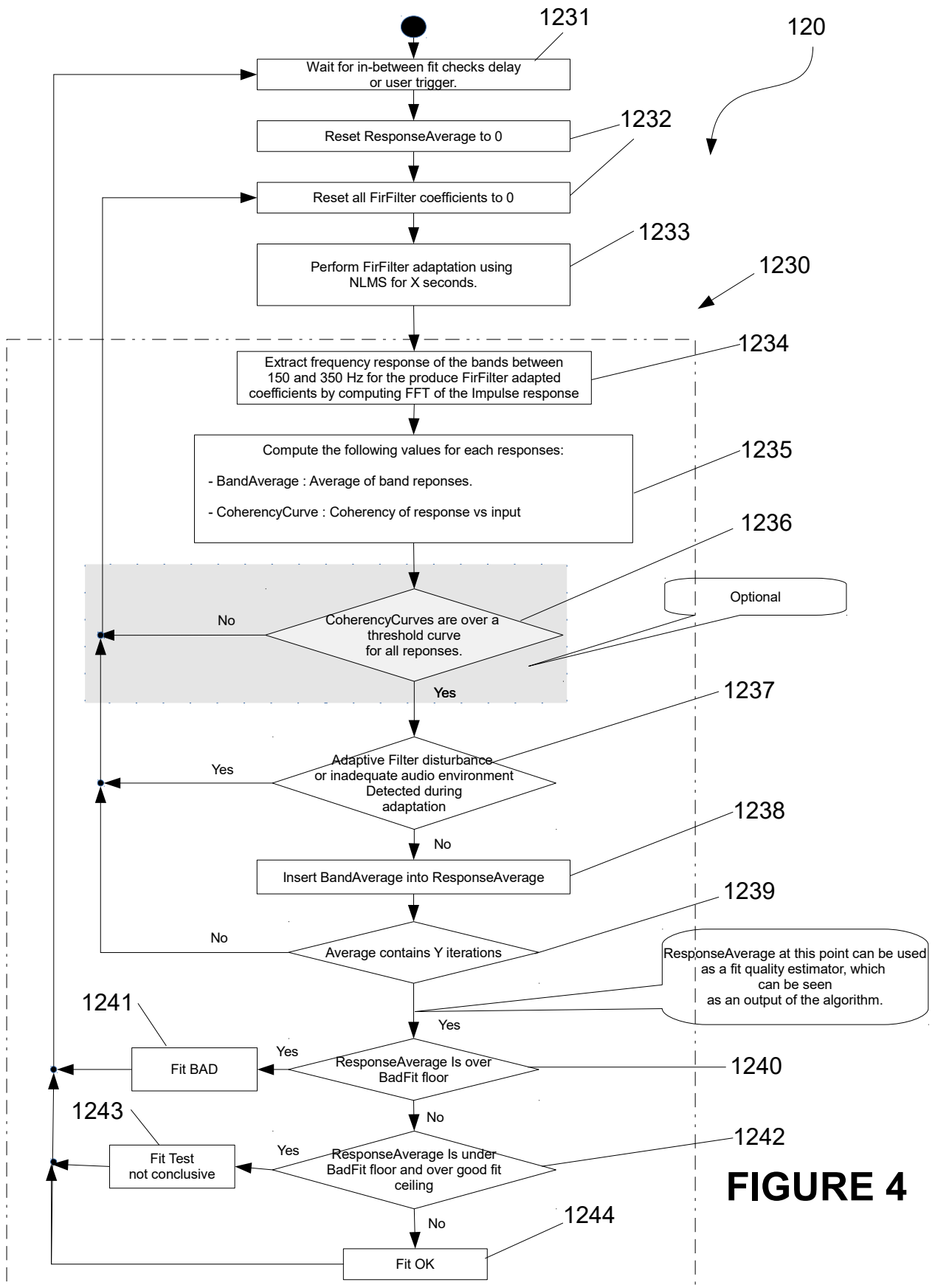

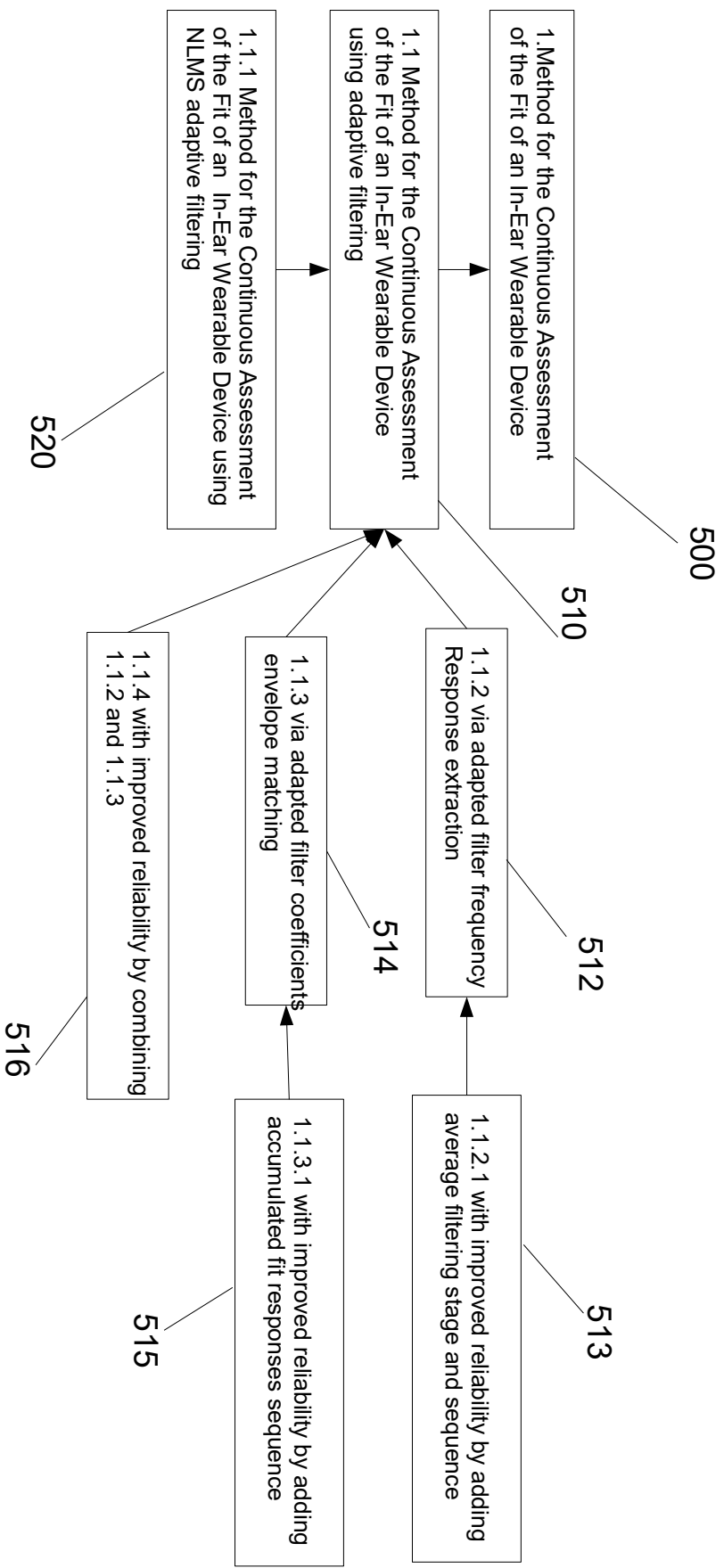

FIGURE 5

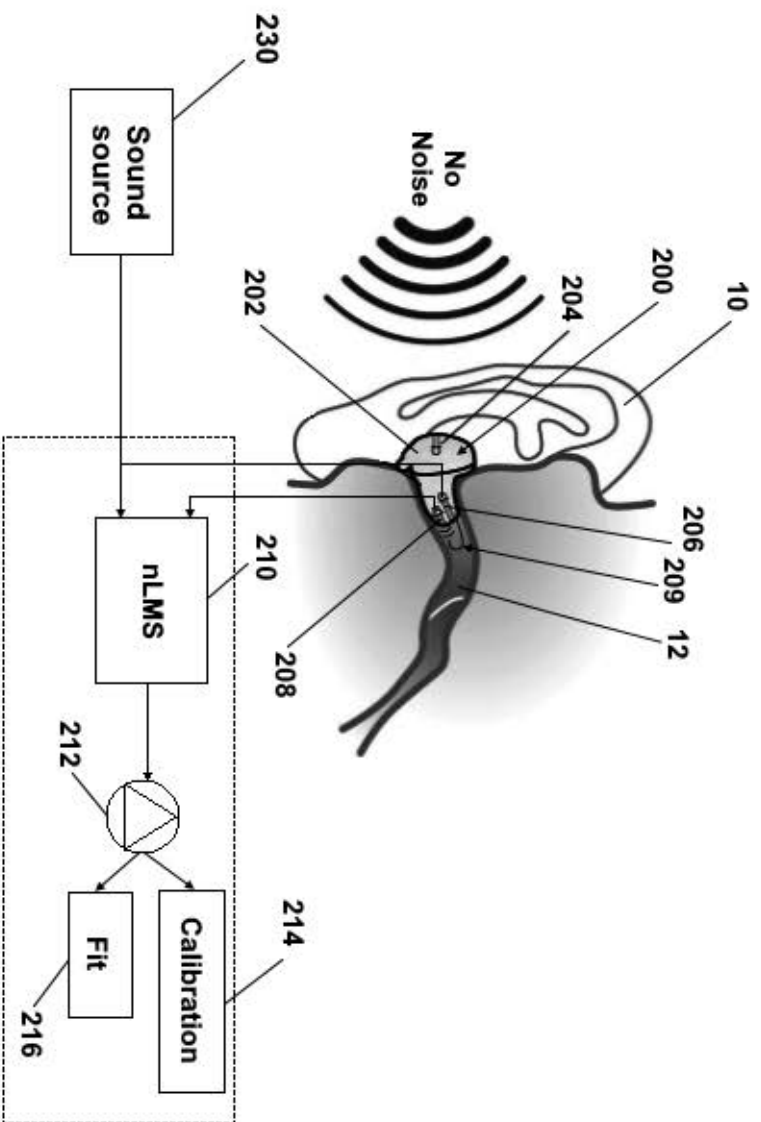

FIGURE 6

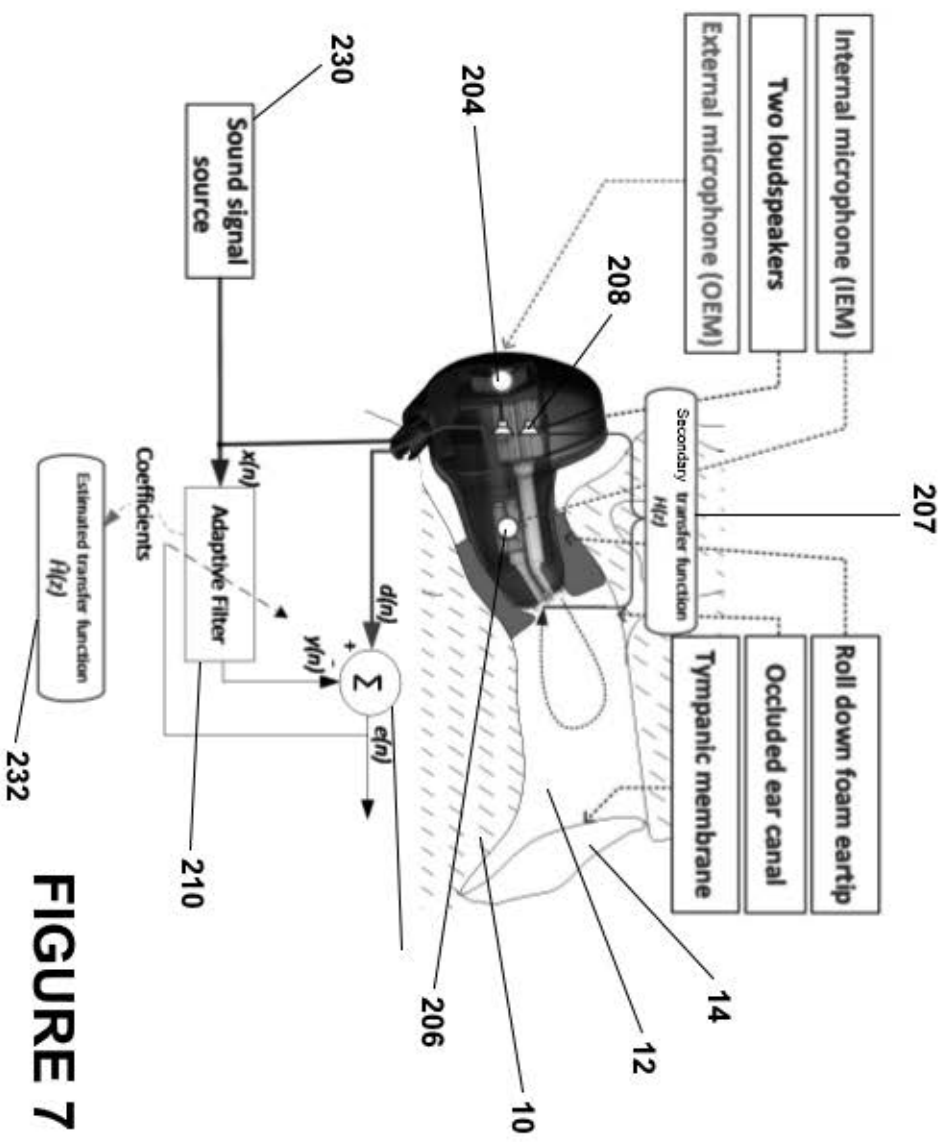

FIGURE 7

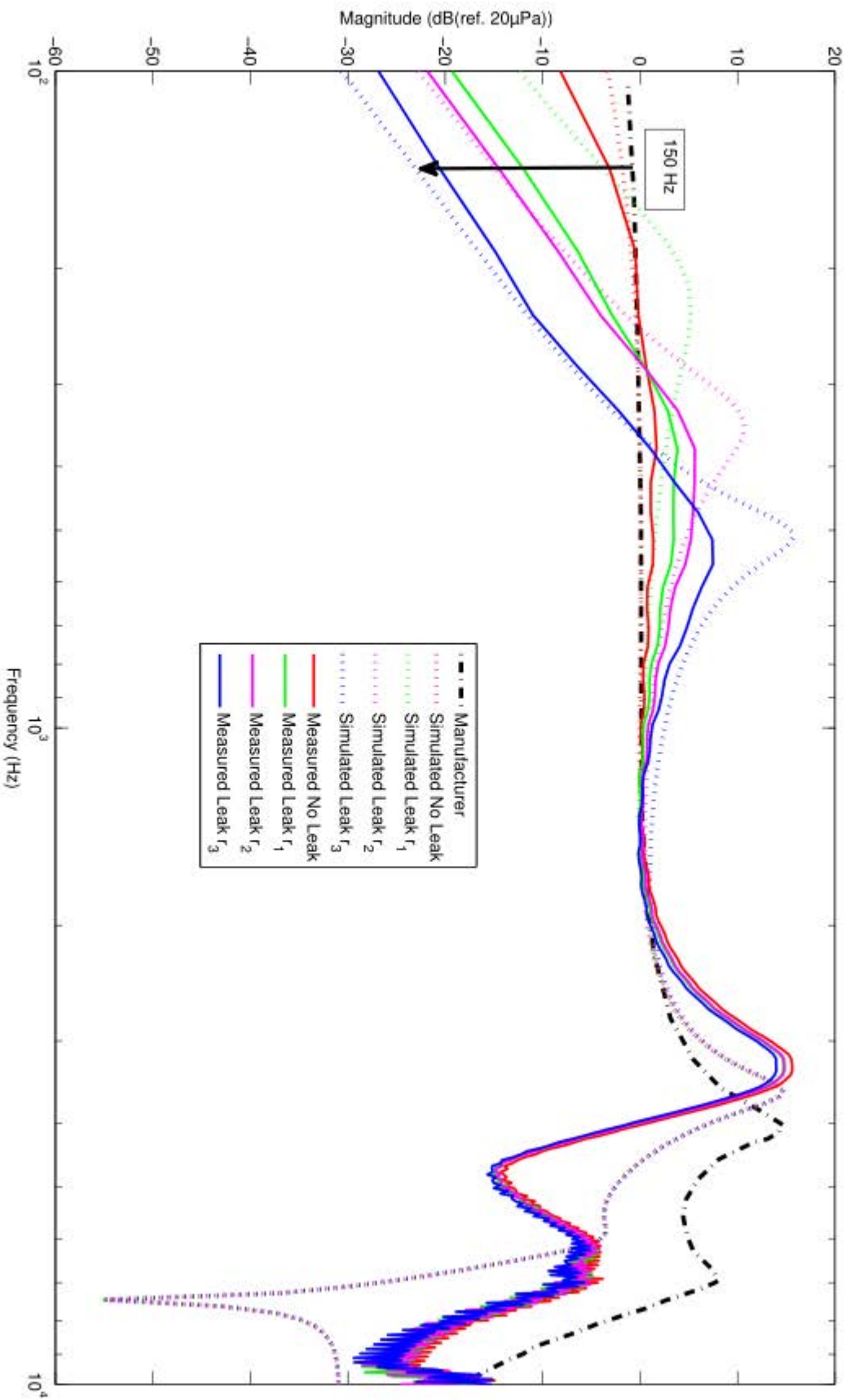

FIGURE 8

FIGURE 9

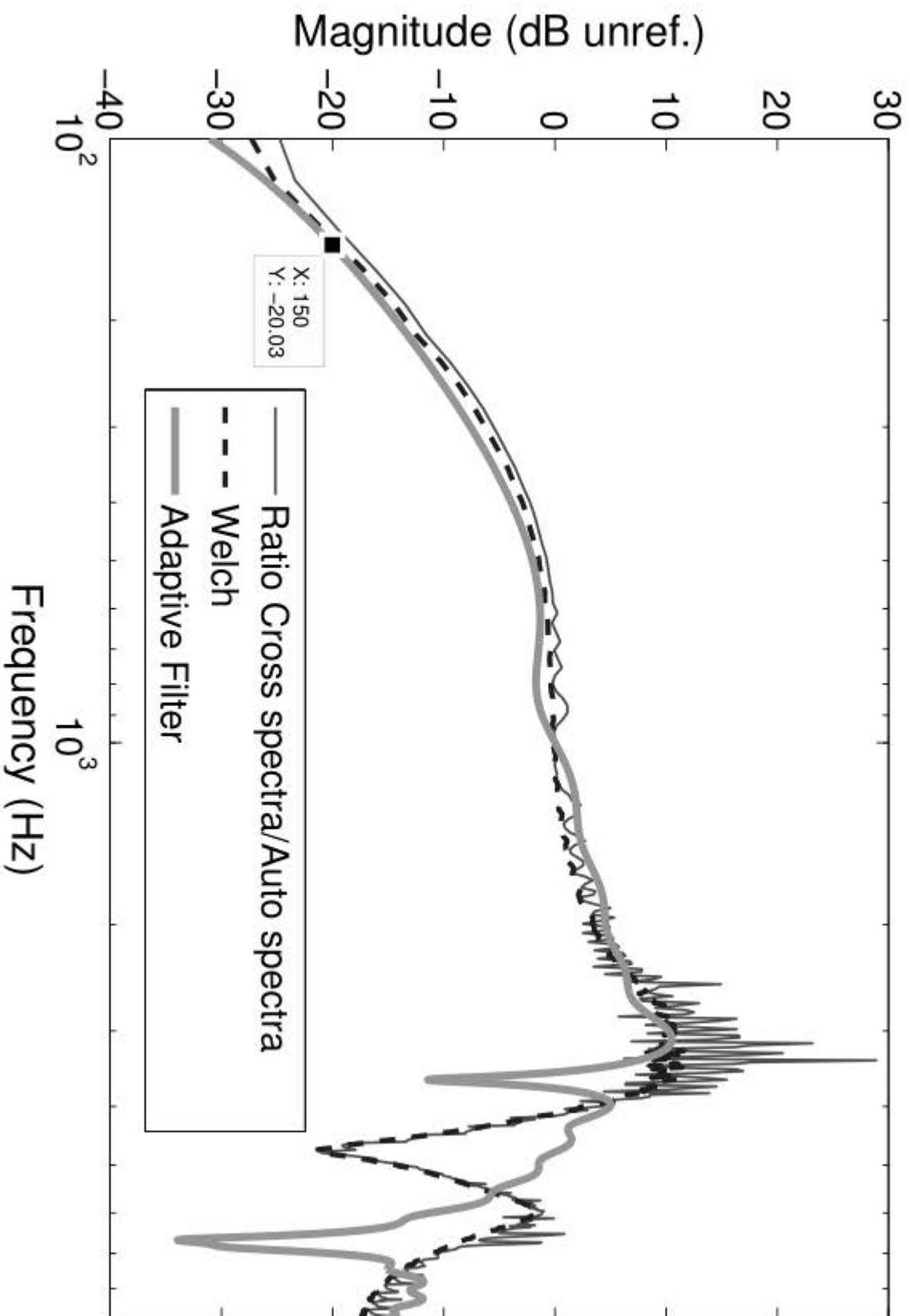
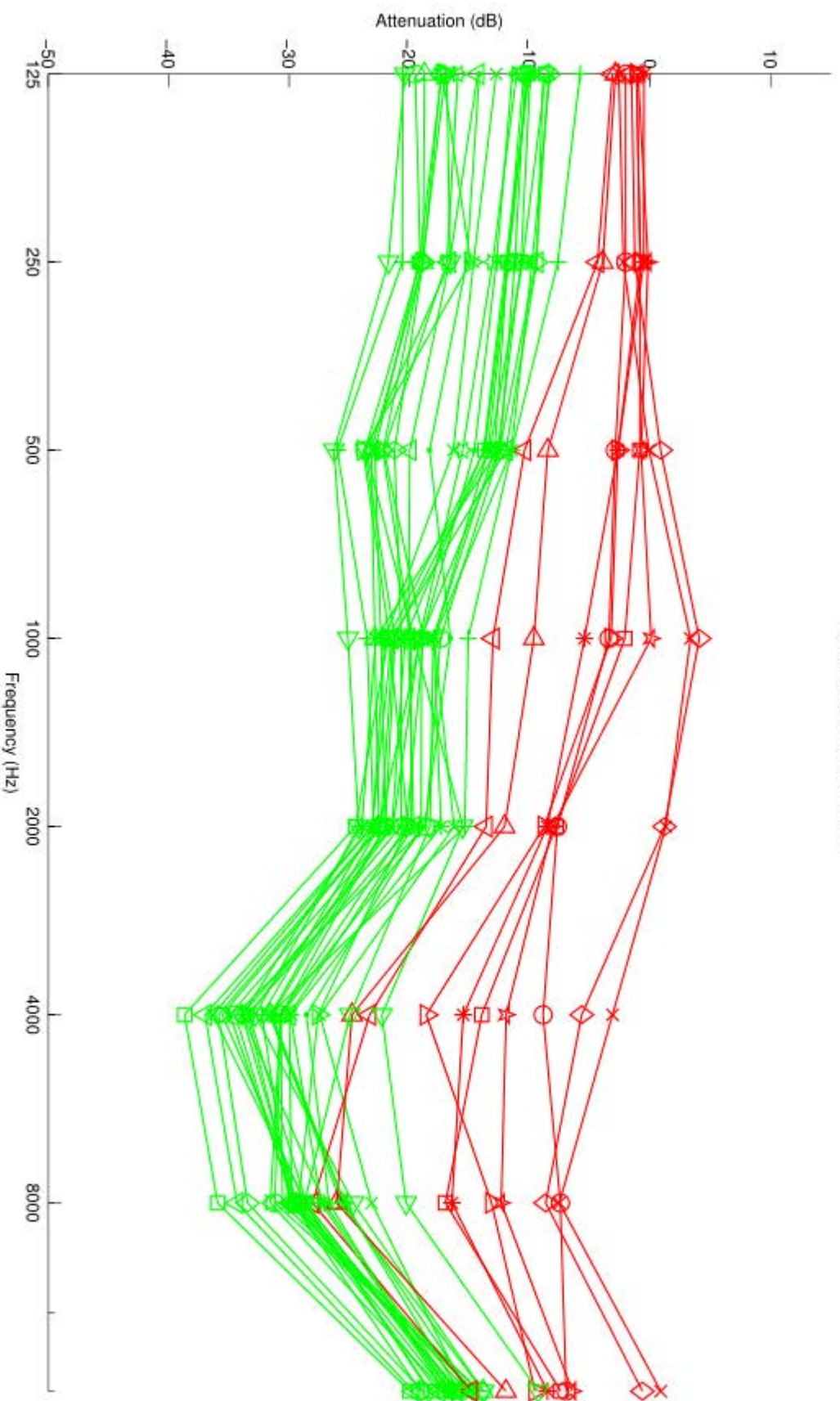

FIGURE 10

Attenuation per octave ratio



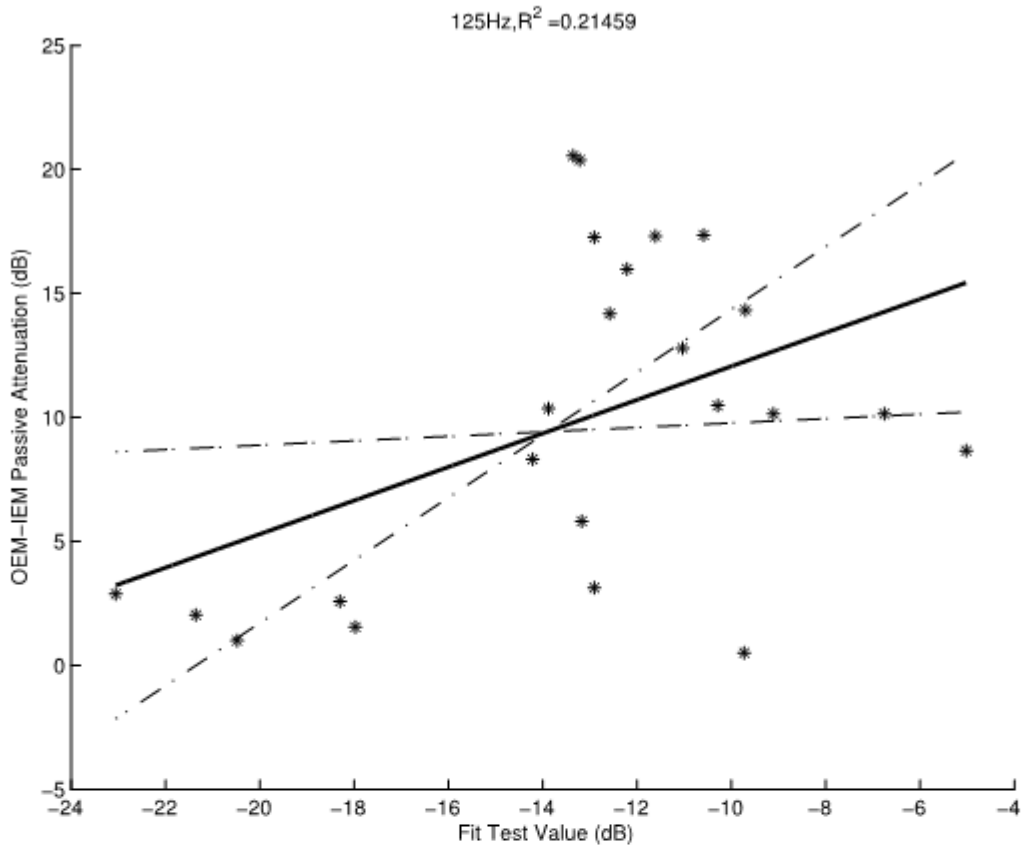

FIGURE 11A

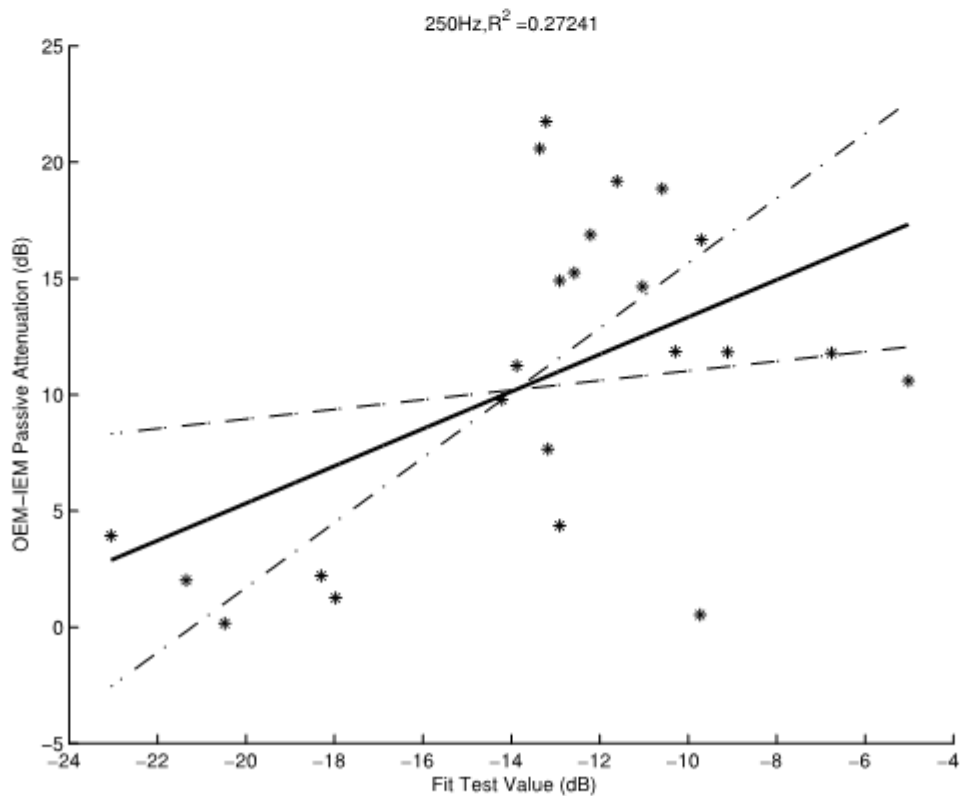

FIGURE 11B

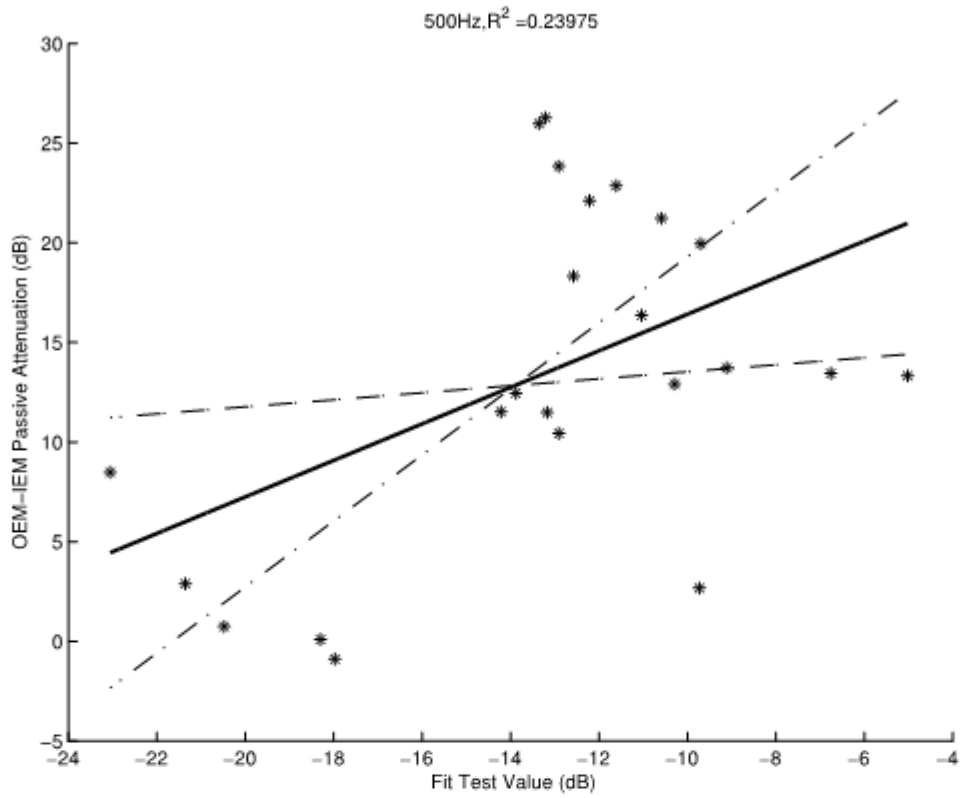

FIGURE 11C

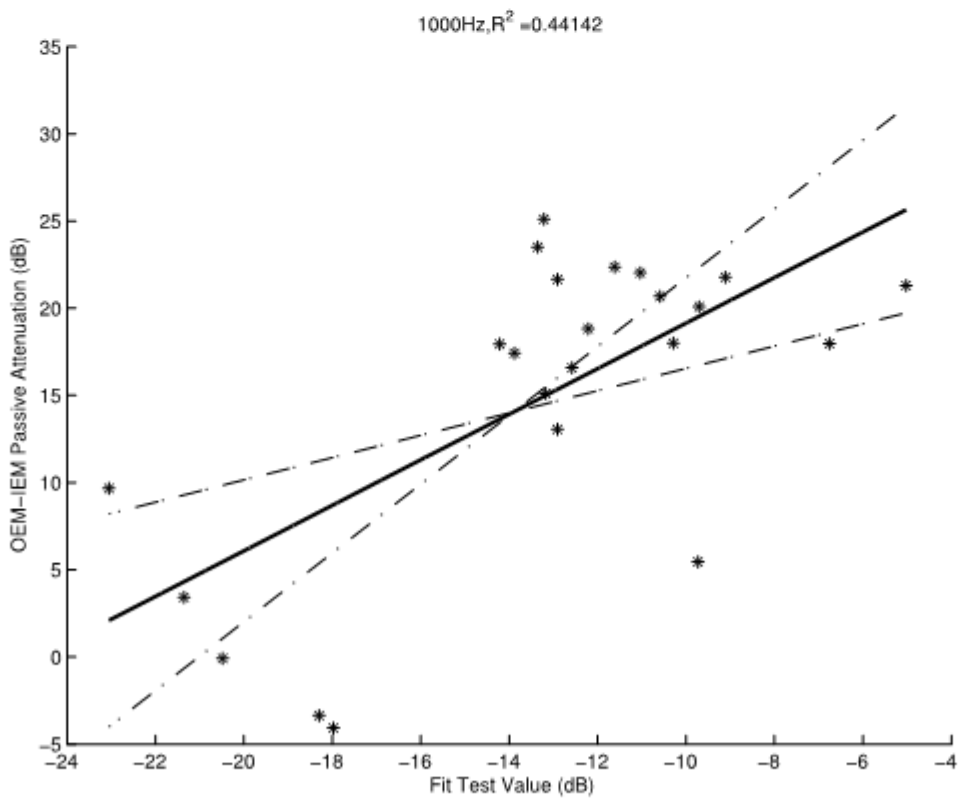

FIGURE 11D

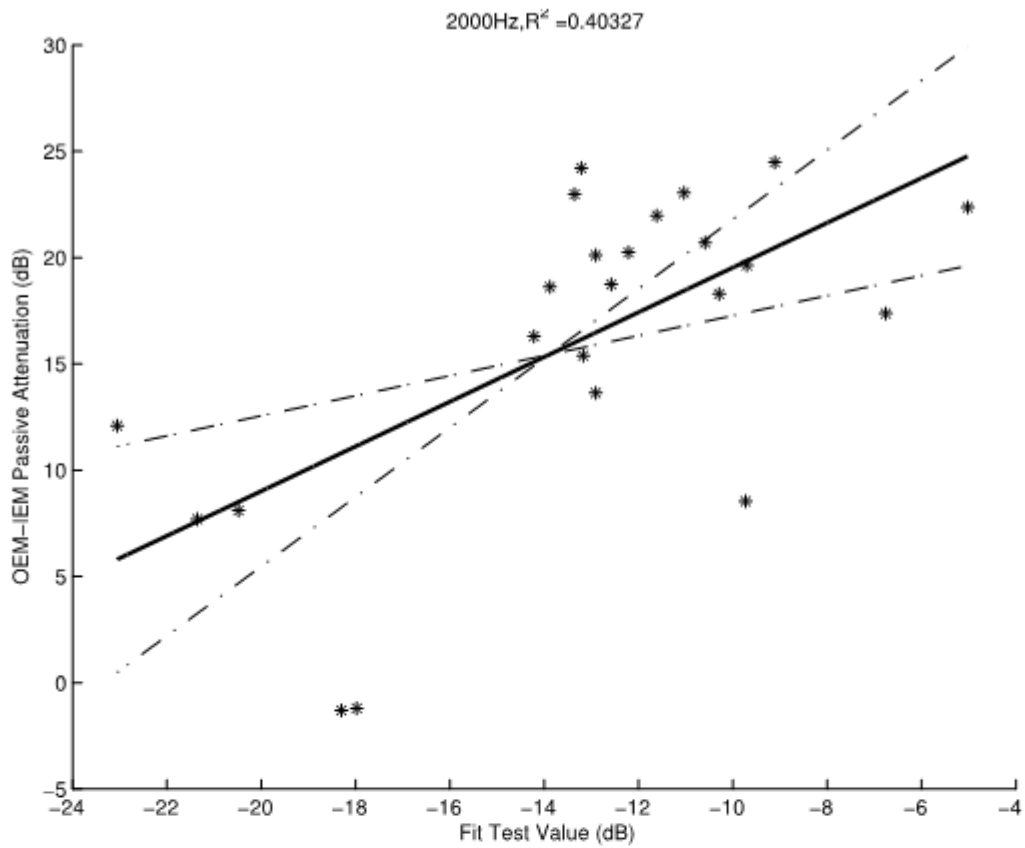

FIGURE 11E

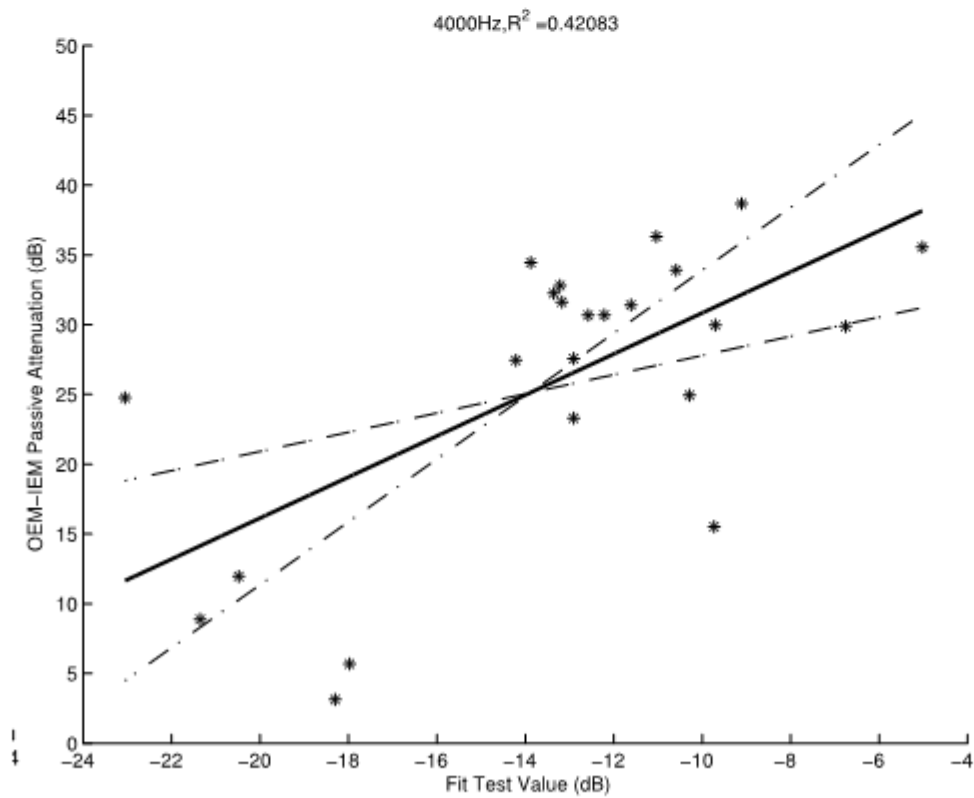

FIGURE 11F

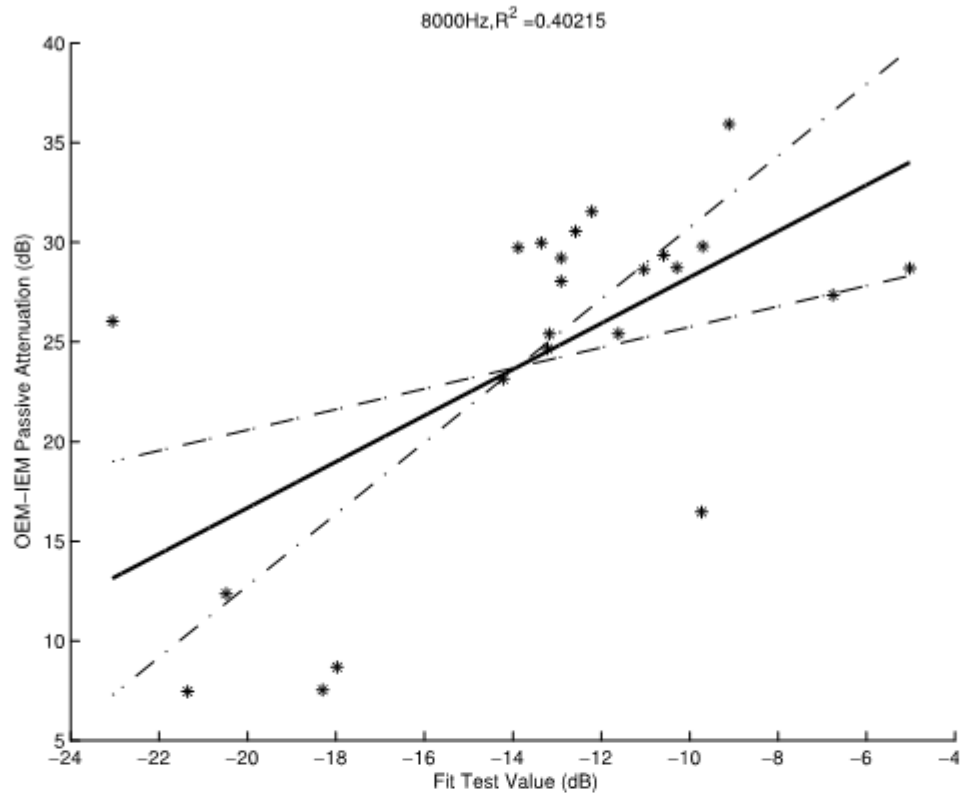

FIGURE 11G

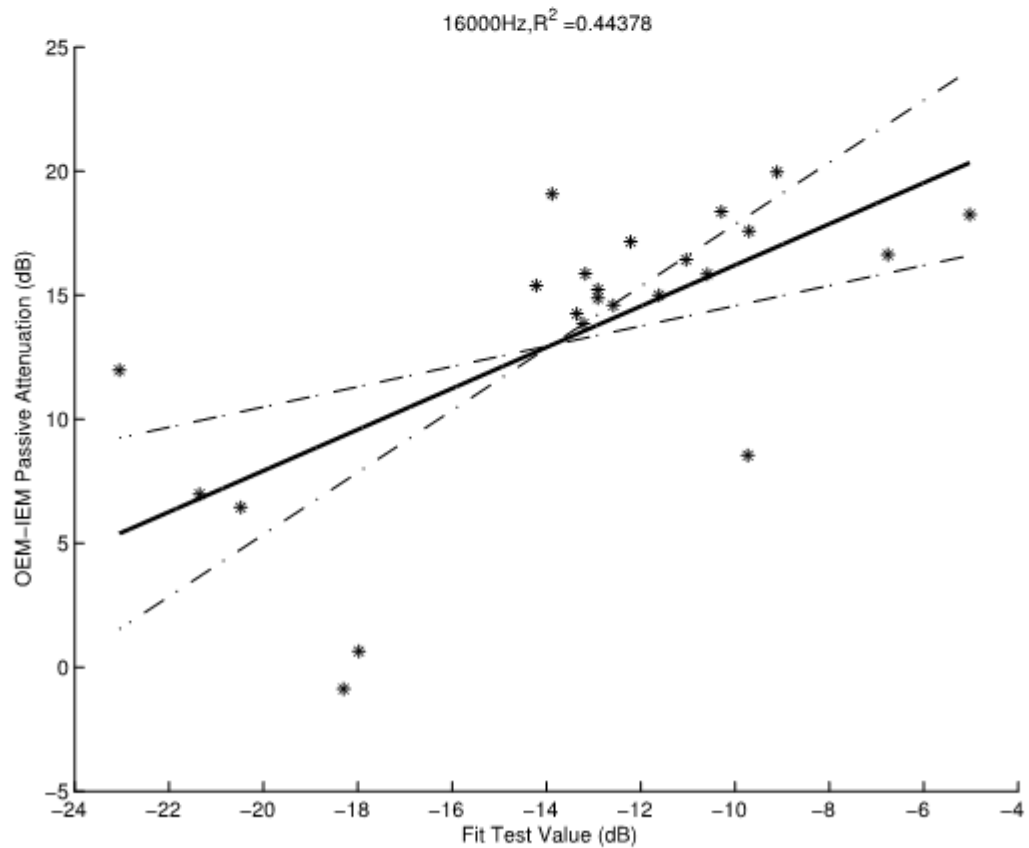

FIGURE 11H

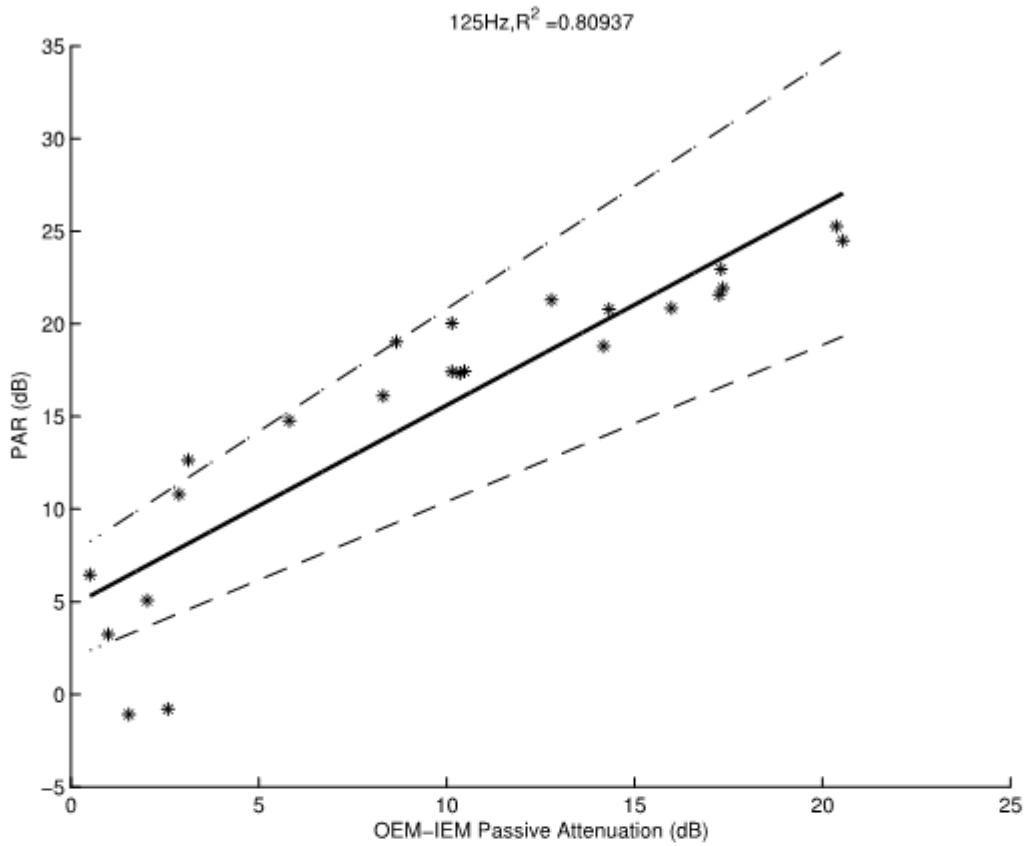

FIGURE 12A

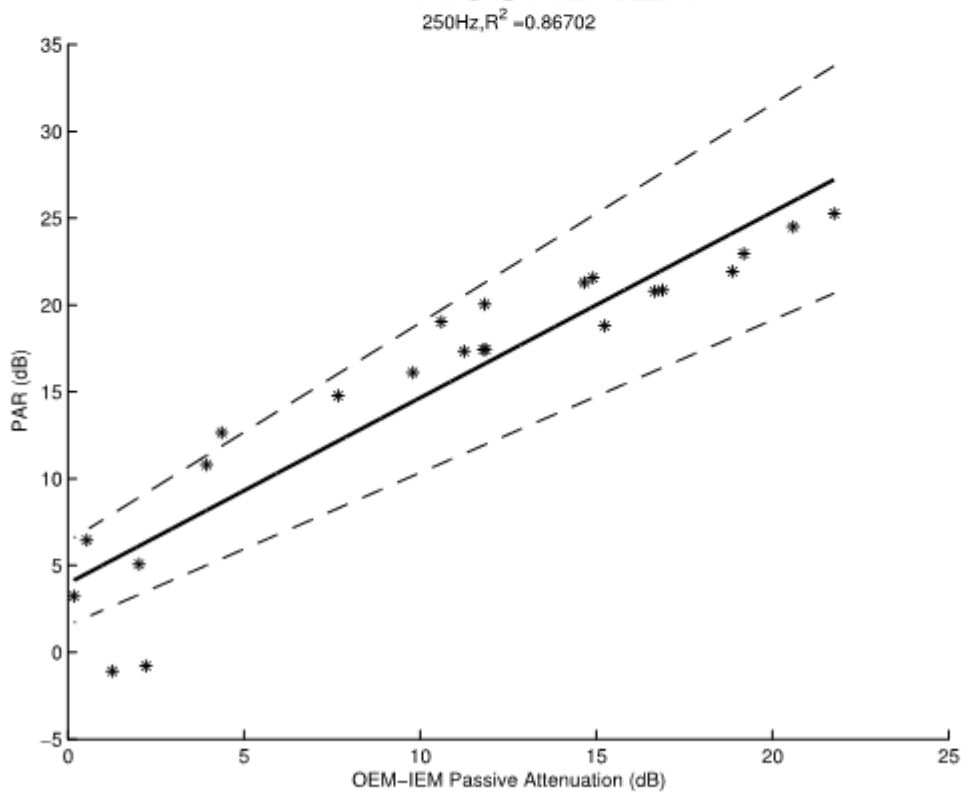

FIGURE 12B

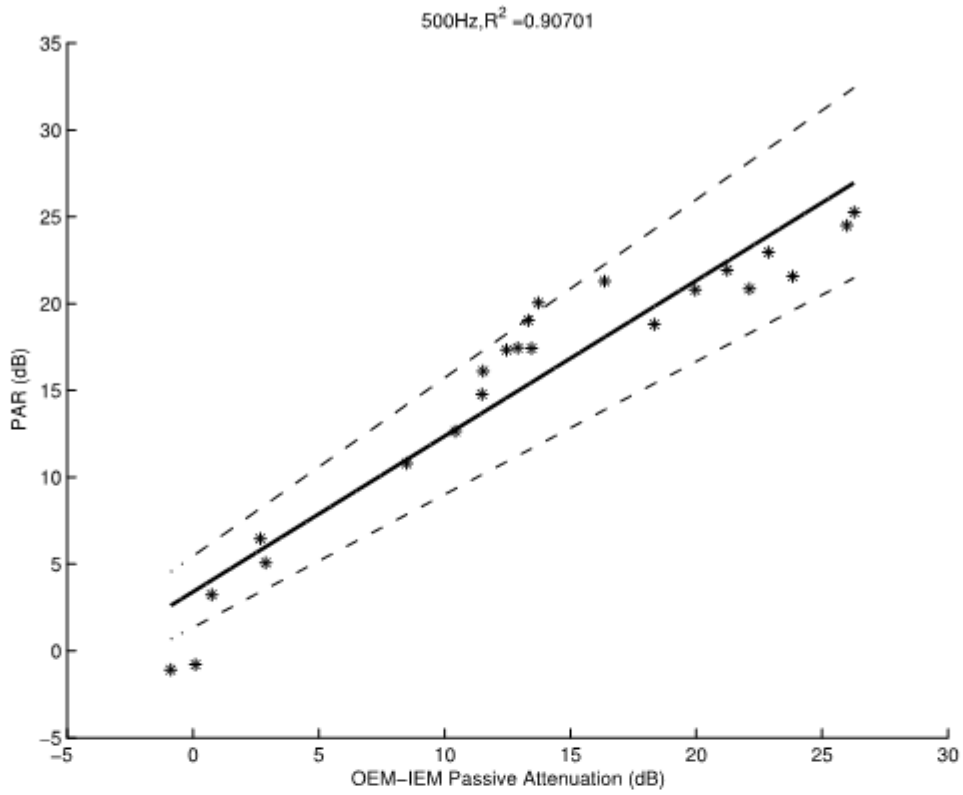

FIGURE 12C

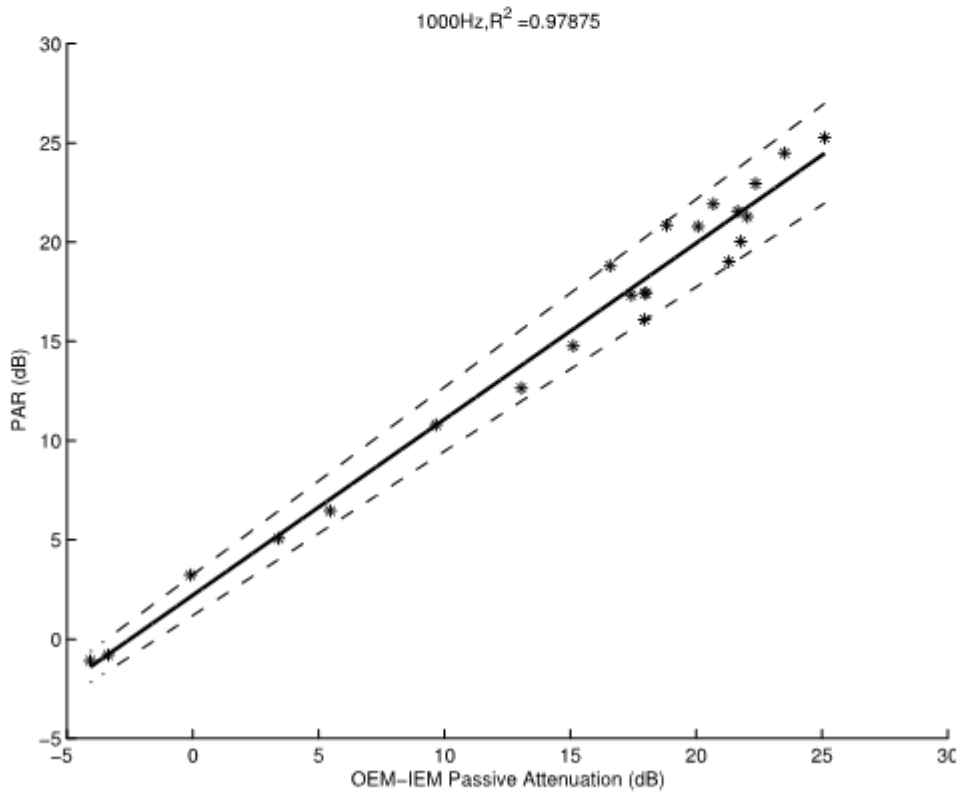

FIGURE 12D

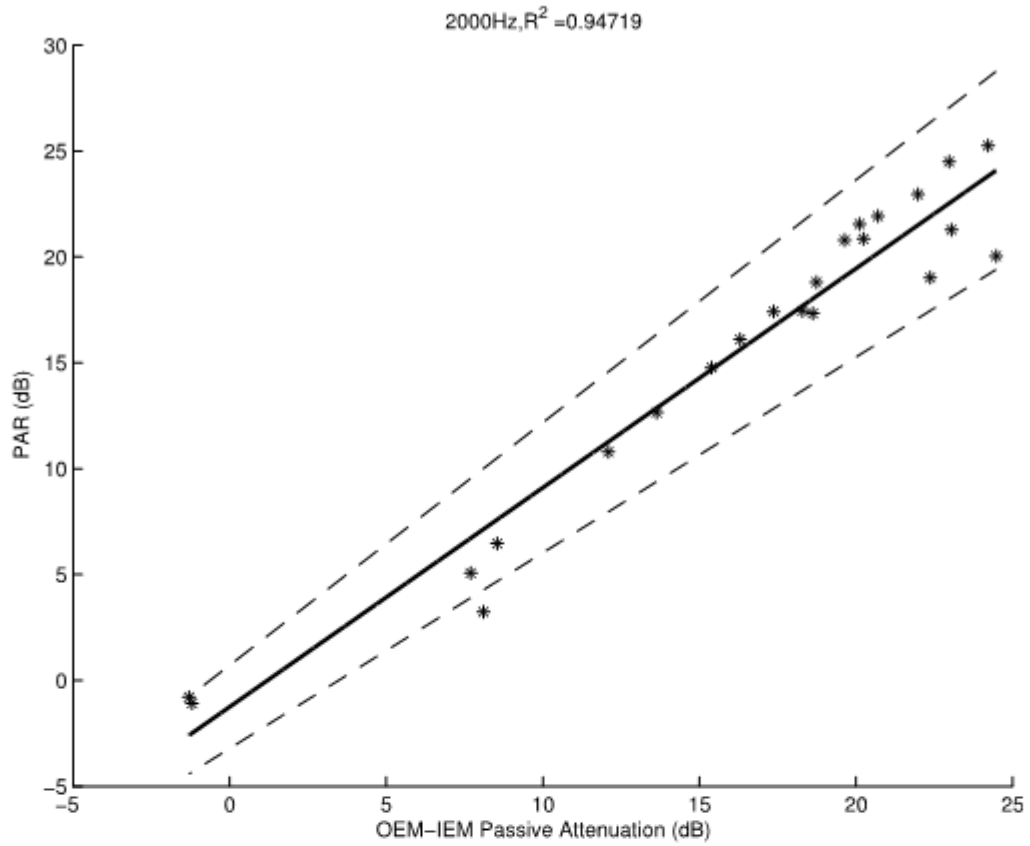

FIGURE 12E

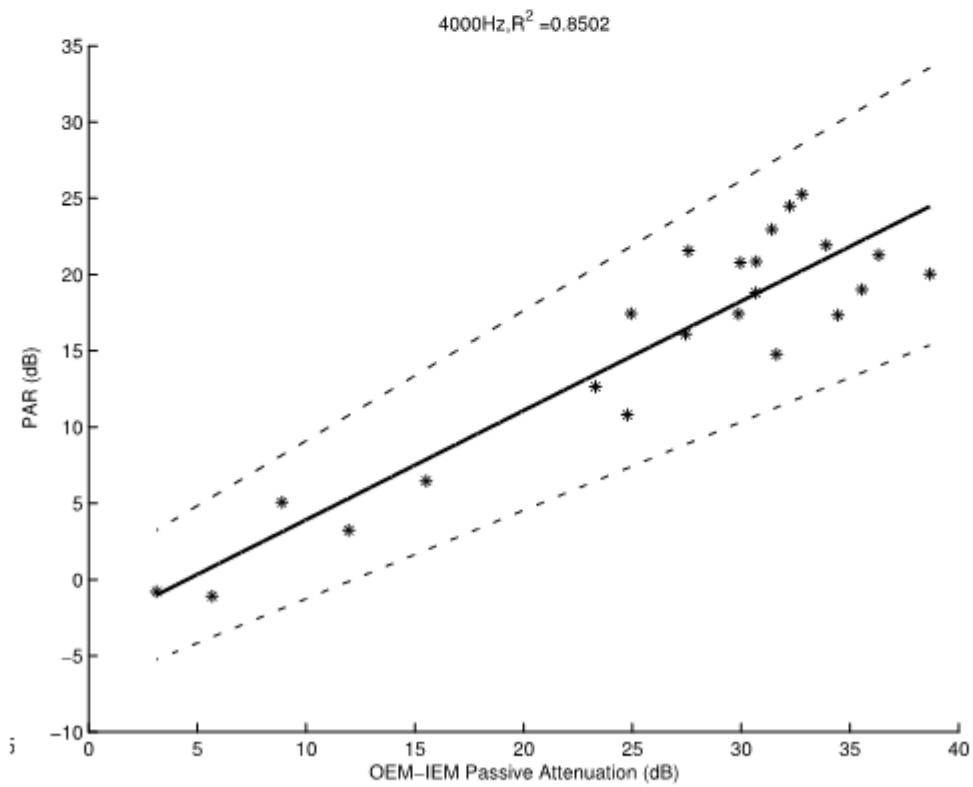

FIGURE 12F

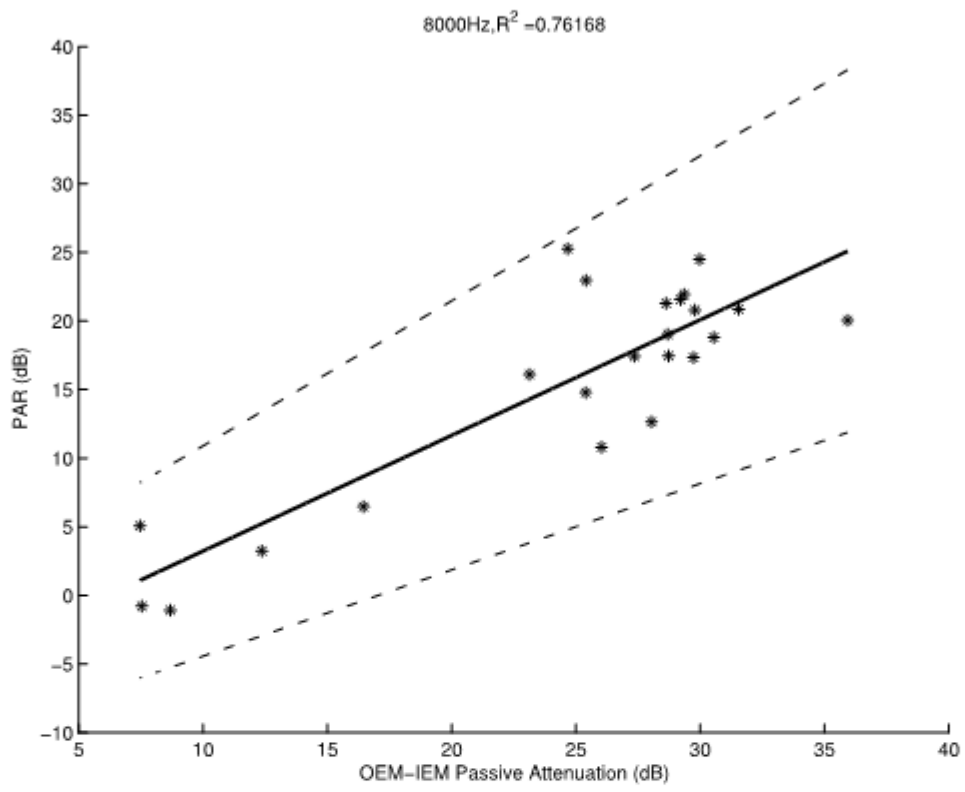

FIGURE 12G

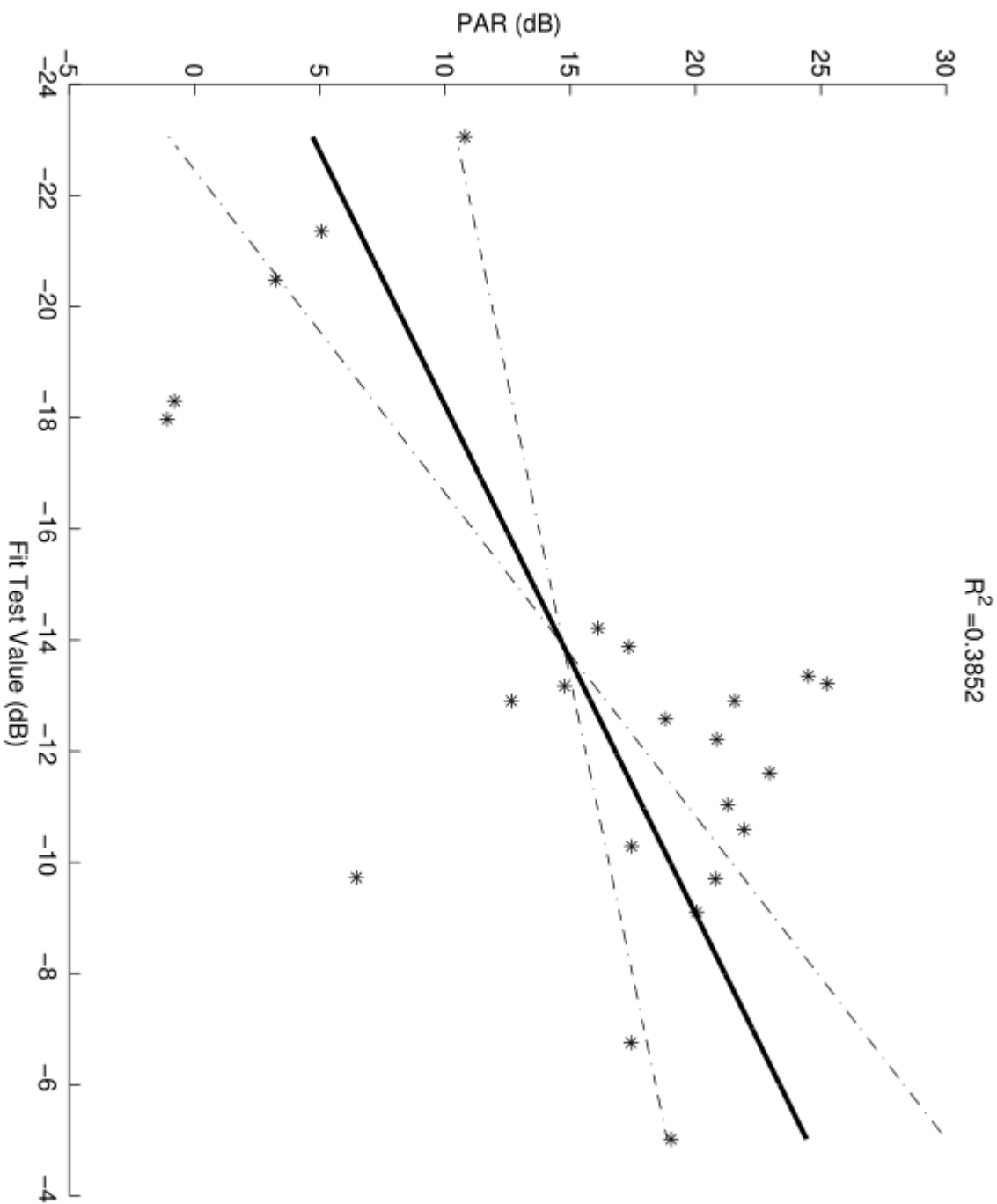

FIGURE 13